

CCS Technical Documentation

RH-44 Series Transceivers

Service Tools

Contents

	Page No
Service Tools.....	5
Models 3586, 3586i	5
Flashing and Testing Setups	10
POS Flash Setup 1	10
Flashing, testing, and tuning with covers on (Setups 2a, 2b, 2c, 2d)	11
Service Setup 2a	12
Service Setup 2b	13
Service Setup 2c	14
Service Setup 2d	15
Automated Tuning and Alignment	16
Automated Tuning and Alignment Equipment List	17
GPS Engine Testing (Model 3586i only).....	17
GPS Testing Equipment	19

Service Tools

Models 3586, 3586i





Photo	Code	Service Tool	Code	Description Info
	JBV-1	Docking Station	0770298	<p>The Docking Station and the Docking Station Adapter are needed for Mbus, Fbus, RF, and audio connections.</p> <p>This setup allows connection between flash promoters. When the audio box is connected, it has to be connected to the phone's audio connector. The Docking Station can be powered by FPS-8 or external power supply.</p>
	MJF-19	Docking Station Adapter	0770359	
	FLA-33	Flash Adapter	0770358	The flash adapter allows FBUS/MBUS connections for flashing.
	DKU-5F	Flash Cable	0080738	<p>To be used with the Spirent UPST and UMPP service software.</p> <p><i>Note: The cable cannot be used as a straight-through USB connection cable.</i></p>

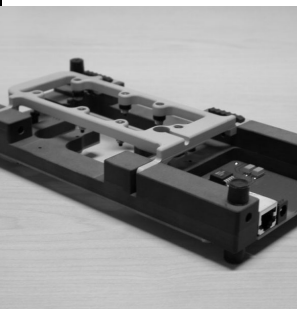

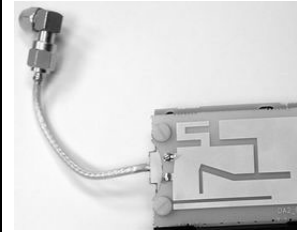

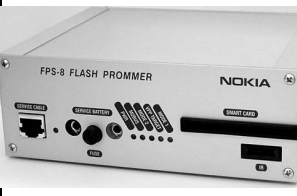
Photo	Code	Service Tool	Code	Description Info
	MJS-57	Module Jig	0770356	This jig allows phone PWB level service and troubleshooting for authorized service centers.
	JBA-12	Audio Box	0770536	The JBA-12 is required for audio testing at authorized service centers.
	CPL-11	GPS RF Coupler (for Model 3586i only)	0770576	Allows testing of the GPS antenna at AMS locations. Shield Box JSX-1A is required.
	JSX-1A	Shield Box	N/A	Allows testing of the GPS antenna with CPL-11 coupler. Contact your local Nokia Regional AMS center for details.
	FPS-8	Flash Prommer	0080321	The Flash Prommer FPS-8 is used for heavy flash.






Photo	Code	Service Tool	Code	Description Info
	ADS-8	Audio Cable	0730268	The Audio Cable connects to the Audio Box JBA-12.
	XCS-4	Mbus/Fbus Cable	0730178	The XCS-4 Service Cable is a modular cable for flashing DCT4 products.
	SCB-3	DC Cable	0730114	The DC Cable SCB-3 is used to connect the docking station to the charger connection (Vin) of the phone to conduct the charger calibration service procedure.
	PCS-1	Power Cable	0730012	The Power Cable PCS-1 is used to connect the service tools (JBV-1, MJS-57) to an external power supply.
	XRS-6	RF Cable	0730231	RF Cable XRS-6 is used to connect the service tools to RF measuring equipment.


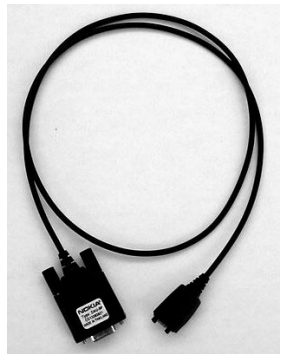




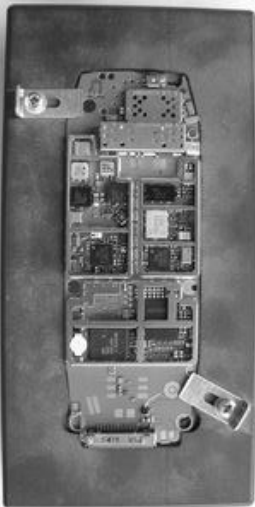

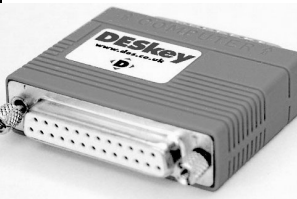
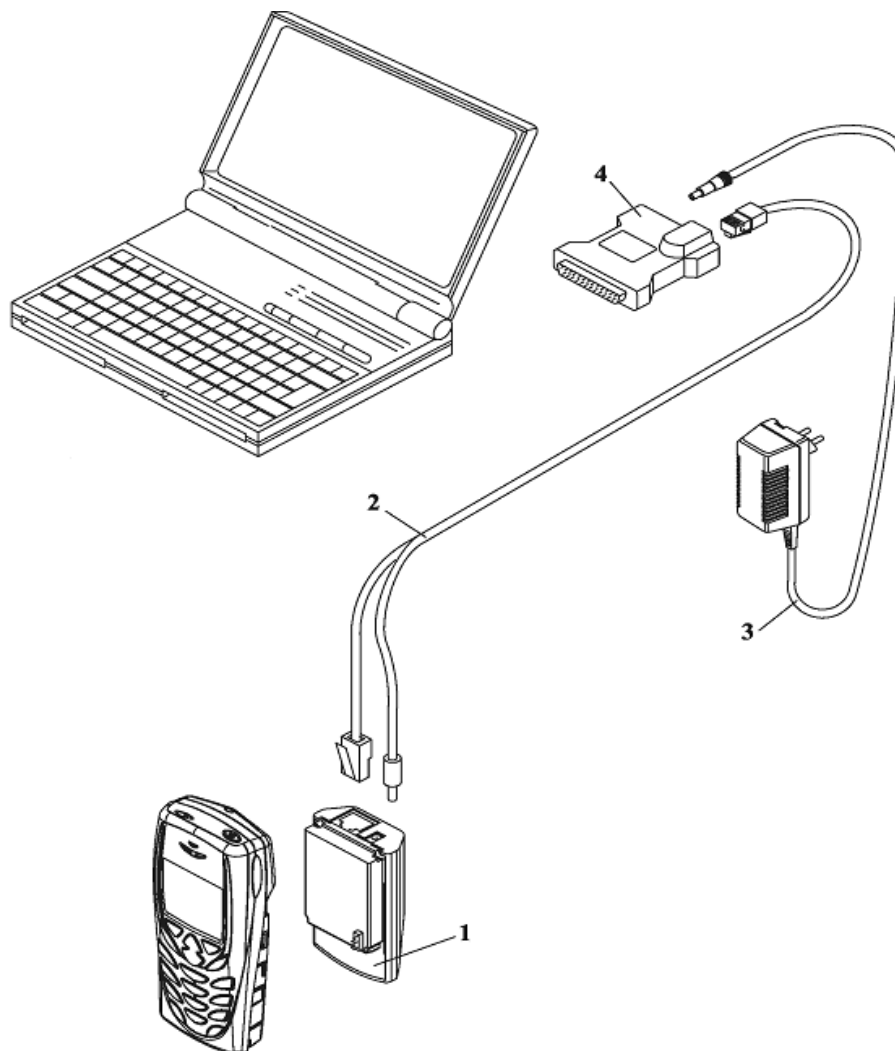
Photo	Code	Service Tool	Code	Description Info
	FLS-4S	POS Flash Adapter	0080543	The Point of Sale (POS) flash is a low-cost software upgrade tool. This requires the XCS-1 cable and ACP-8U for operation.
	DAU-9T	FBUS Cable	0730267	The MBUS cable DAU-9T provides a connection from the serial port of the computer to the system connector of the phone.
	XRS-11	RF Test Cable	0730265	Allows testing of the CDMA RF (requires the SA-7 RF Support)
	SA-7	RF Support	0770562	Serves as a guide for the RF test cable when performing Galvanic CDMA measurements. Use with XRS-11 RF Cable.
	XRS-4	RF Test Cable	0730221	Allows testing of the GPS RF (Requires the SA-8 RF Support).
	SA-8	RF Support (for Model 3586i only)	0770563	Serves as a guide for the RF test cable when performing Galvanic GPS measurements. Use with XRS-4 RF Cable.

Photo	Code	Service Tool	Code	Description Info
	MJS-58	Rework Jig	0770357	Allows easy soldering or desoldering of components during repairs.
	SS-1	Test A-cover	0770568	The accessory allows the technician to replace the handset's original A-cover with one that provides access to the CDMA RF connector. This accessory is best suited for test cases where the UI (Keypad + LCD) functionality is required. This accessory only supports the XRS-4 RF Test Cable.
	PKD-1	SW Security Device	0750018	<p>SW security device PKD-1 is hardware device that, when connected to the parallel (LPT) port of the PC, enables the use of the service software. Without the dongle present, it is not possible to use the service software. Printers or other peripheral devices can be connected to the PC through the dongle, if needed.</p> <p><i>Caution: Make sure that you have switched off the PC and the printer before making connections!</i></p> <p><i>Caution: Do not connect the PKD-1 to the serial port. You may damage your PKD-1!</i></p>

Flashing and Testing Setups

POS Flash Setup 1

Figure 1: View of POS flash



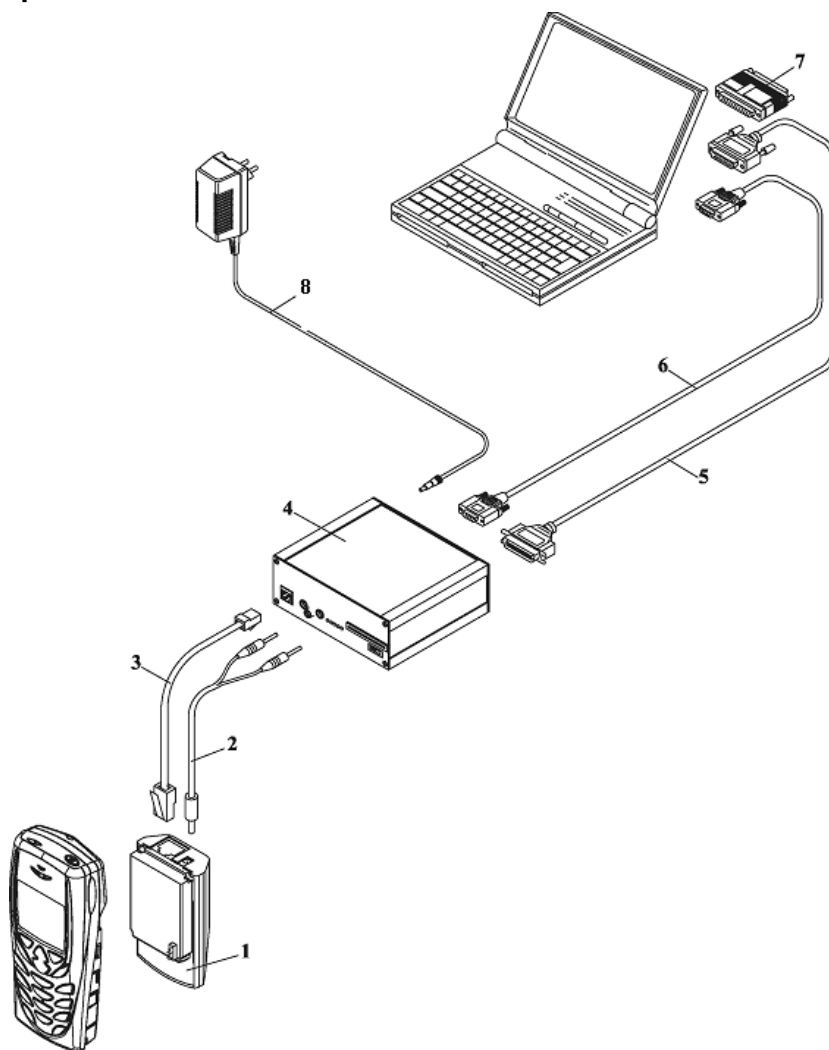
Item	Name	Type	Code
1	POS Flash loading adapter	FLA-33	0770358
2	Service cable	XCS-1	0730218
3	AC charger	ACP-8F	0680032
4	POS flash dongle	FLS-4S	0080543
not pictured	POS Software	Diego/UPST	

Flashing, testing, and tuning with covers on (Setups 2a, 2b, 2c, 2d)

Tightened performance specifications require more precise equipment and methods for testing and alignment. Manual tuning can't provide accurate results for RH-44 products, which means that this task has to be automated.

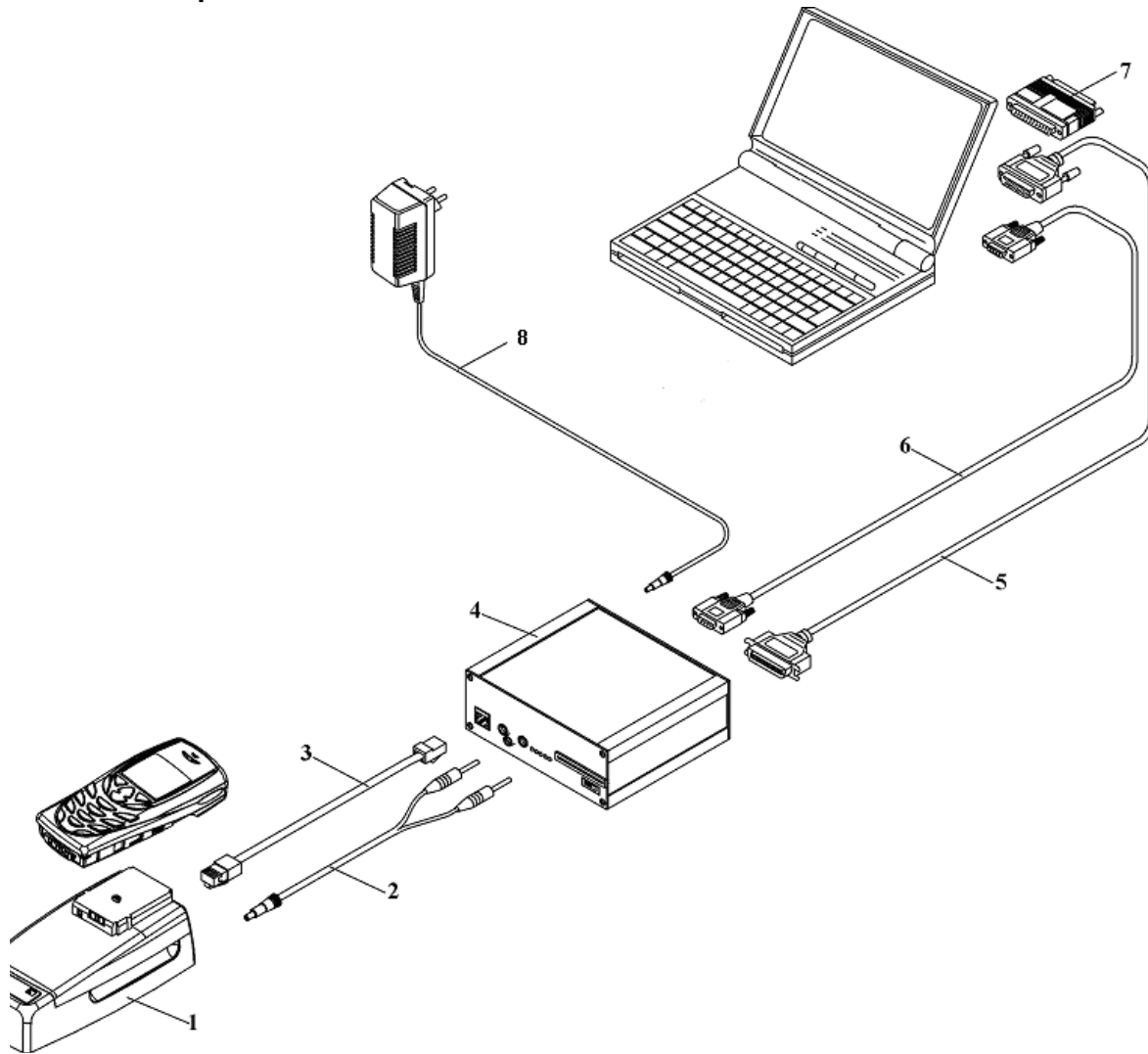
These setups are intended to be used with Phoenix SW. With the Phoenix SW, it is possible to do manual testing and automated tuning.

Service Setup 2a



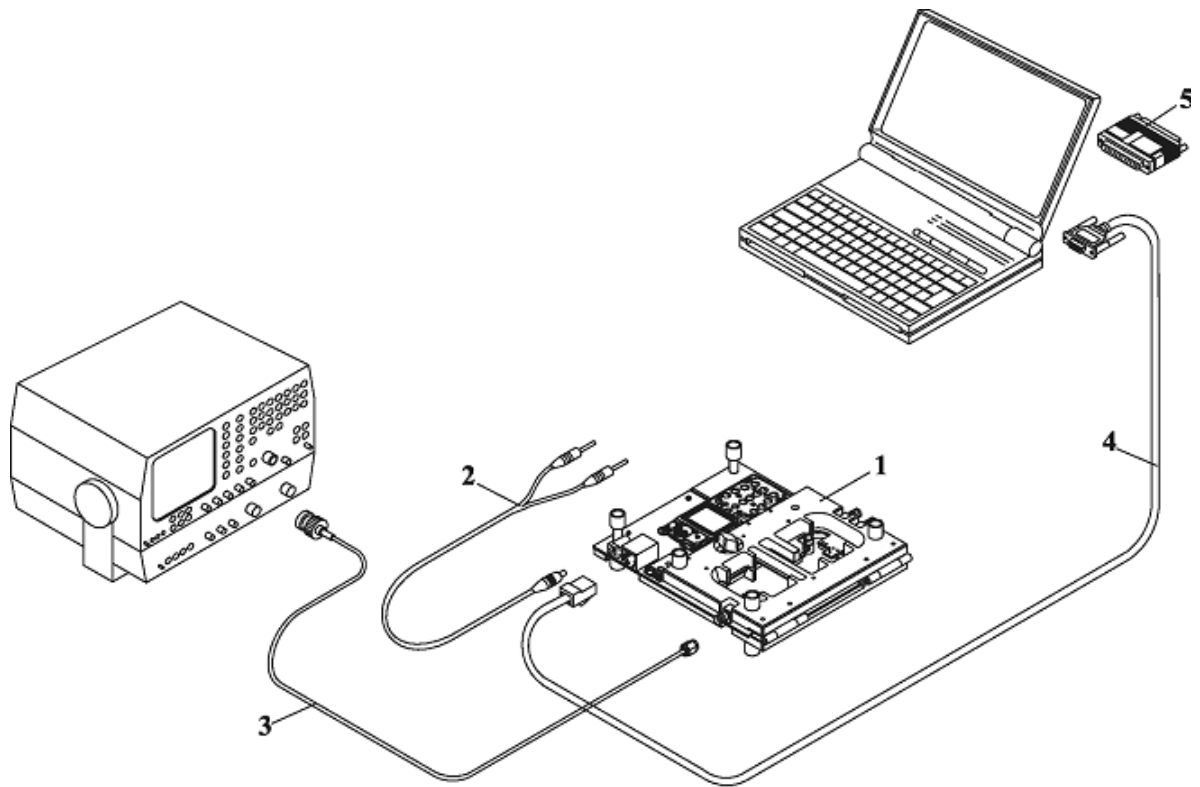
Item	Name	Type	Code
1	POS flash loading adapter	FLA-33	0770358
2	Power cable (included in FLA-14 sales pack)	FLC-2	0730185
3	Modular cable	XCS-4	0730178
4	Flash prommer box	FPS-8	0080321
5	Printer cable (included in FPS-8 sales pack)	CA-10DS	0730298
6	D9-D9 cable (included in FPS-8 sales pack)	AXS-4	0730090
7	Software protection key	PKD-1	0750018
8	AC charger	ACP-8F	0680032

Service Setup 2b



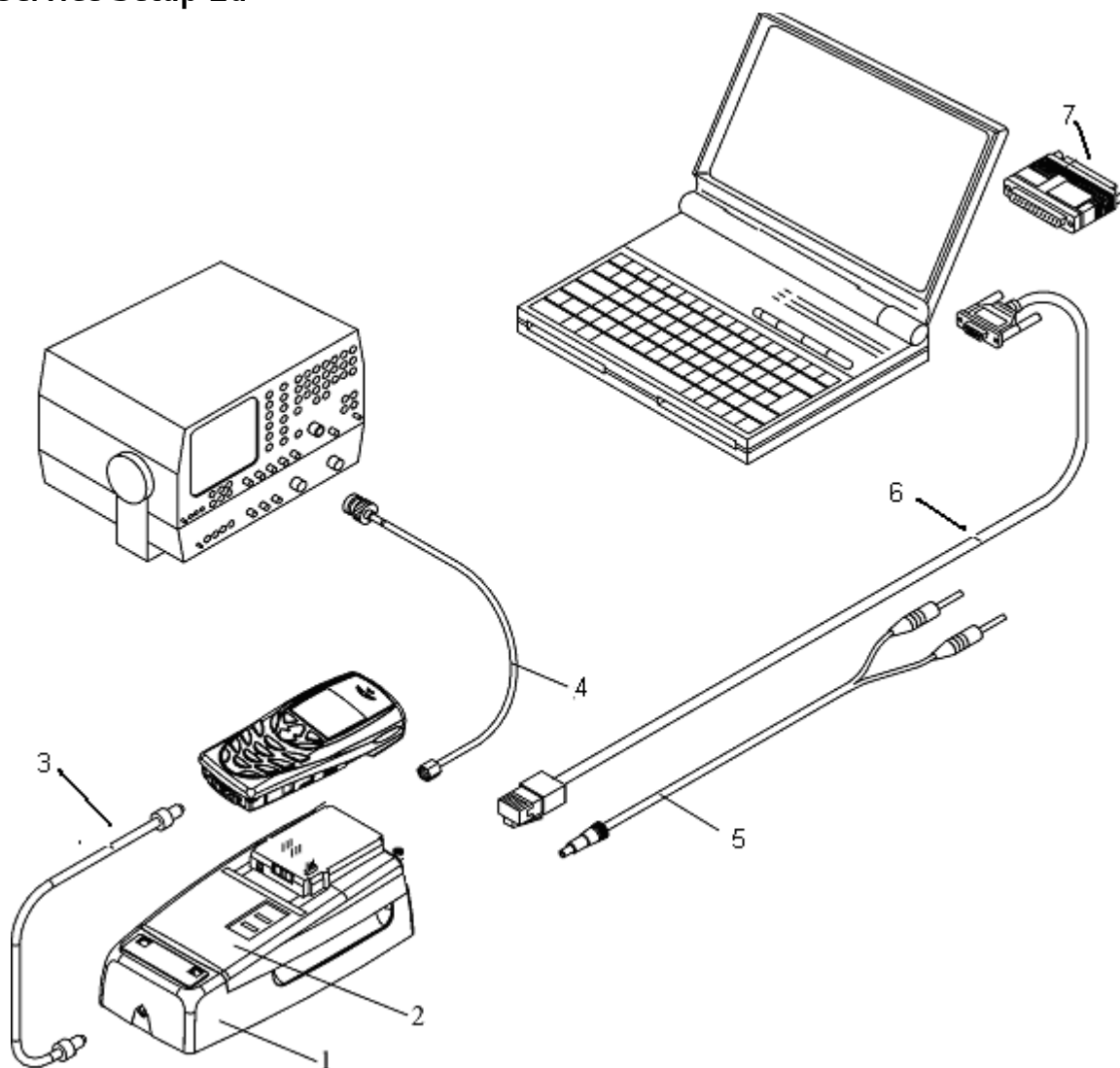
Item	Name	Type	Code
1	Docking station Docking station adapter	JBV-1 MJF-19	0770298 0770359
2	DC power cable	PCS-1	0730012
3	Modular cable	XCS-4	0730178
4	Flash prommer box	FPS-8	0080321
5	Printer cable (included in FPS-8 sales pack)	CA-10DS	0730298
6	D9-D9 cable (included in FPS-8 sales pack)	AXS-4	0730090
7	Software protection key	PKD-1	0750018
8	AC charger	ACP-8F	0680032

Service Setup 2c



Item	Name	Type	Code
1	Module jig	MJS-57	0770356
2	DC power cable	PCS-1	0730012
3	RF antenna cable	XRS-6	0730231
4	Service MBUS cable	DAU-9S	0730108
5	Software protection key	PKD-1	0750018

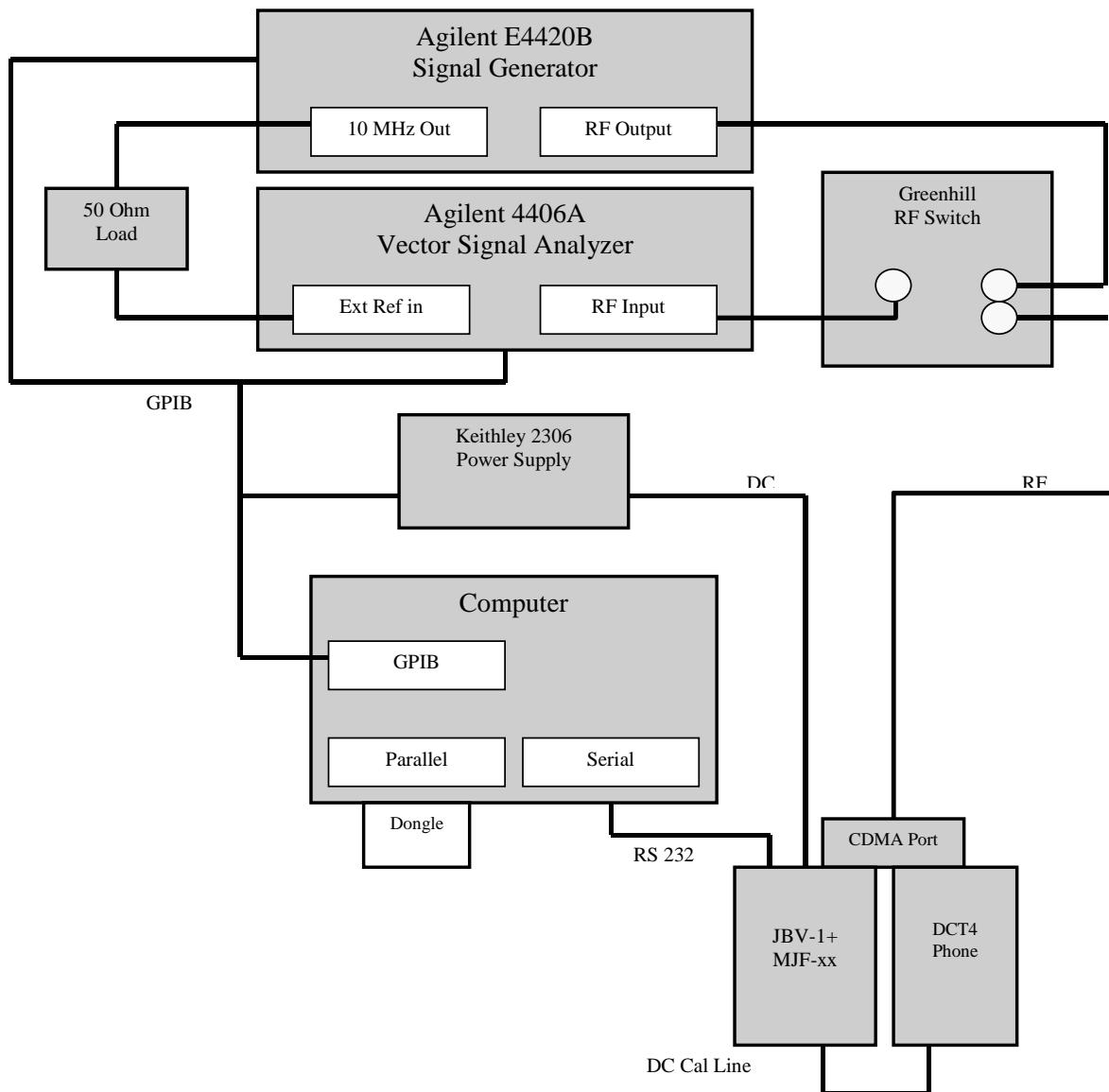
Service Setup 2d



Item	Name	Type	Code
1	Docking station	JBV-1	0770298
2	Docking station adapter	MJF-19	0770359
3	DC-DC cable	SCB-3	0730114
4	RF antenna cable	XRS-6	0730231
5	DC power cable	PCS-1	0730012
6	Service MBUS cable	DAU-9S	0730108
7	Software protection key	PKD-1	0750018

Automated Tuning and Alignment

This setup is used for tuning of the handset at Nokia Authorized Service Centers.



Automated Tuning and Alignment Equipment List

ITEM	NAME	MFR	Model #	QTY	COMMENT
1	Vector Signal Analyzer	Agilent	E4406A	1	Options B78, BAC and BAE
2	Signal Generator	Agilent	E4421B	1	Digital signal generator with high stability oscillator and high spectral purity.
3	Momentum Series	Agilent	8960C	1	CDMA tester for IS-95, IS-2000 and AMPS protocols.
4	Power Supply	Keithly	K2306	2	Programmable with sense wire.
5	Win2000 PC			1	Dell with Pentium III or above, network card, 256M RAM, 20GB HD, CD-ROM, etc.
6	NI-GPIB Interface	NI	GPIB-USB-A	2	USB to GPIB adapter (184983G-01)
7	Docking Station	Nokia	JBV-1	1	Consult your local Nokia After Market Services office for more information.
9	RF Switches	Green Hill	TVi9901	1	Consult your local Nokia After Market Services office for more information.

Note: A Test Sequence File is required to perform "Auto tune" on this phone. In addition, Phoenix needs to have the Auto Tune function installed. Consult you local Nokia After Market Services office more information.

GPS Engine Testing (Model 3586i only)

This setup will be used for testing of the GPS Engine at Nokia Authorized Service Centers. Both Galvanic and Radiated tests will be supported. The GPS Test component in Phoenix will provide functionality to perform these tests. See Figure 2 and Figure 3. Refer to the GPS Troubleshooting Guide for more details regarding GPS Engine troubleshooting.

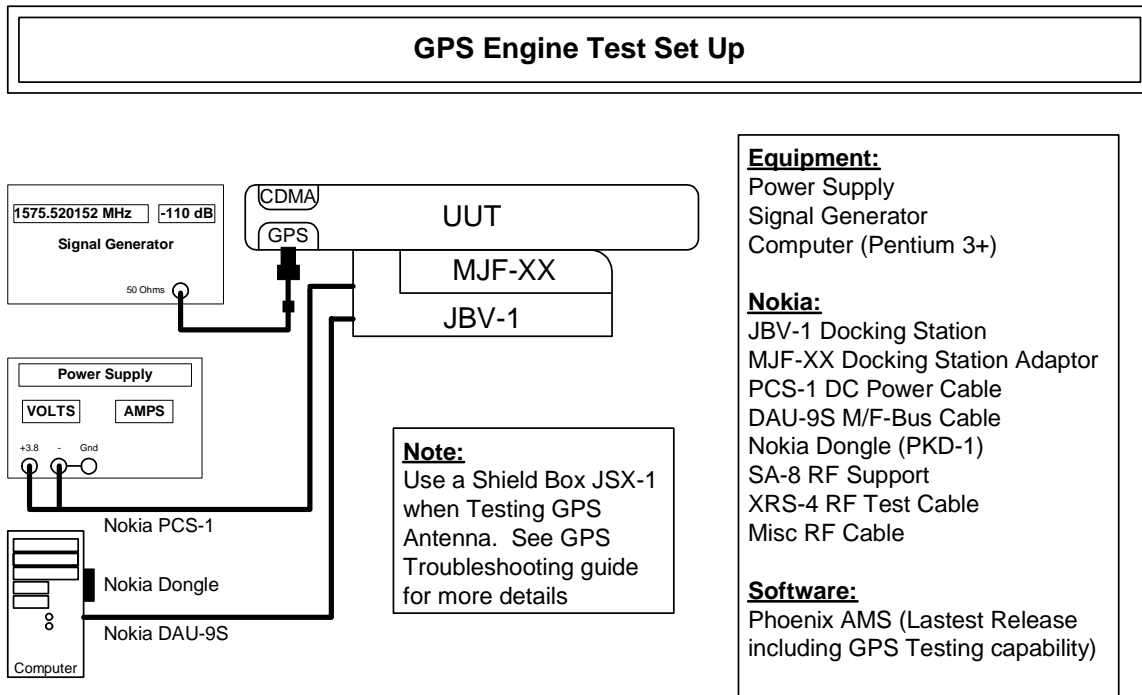


Figure 2: GPS Galvanic Testing (Model 3586i only)

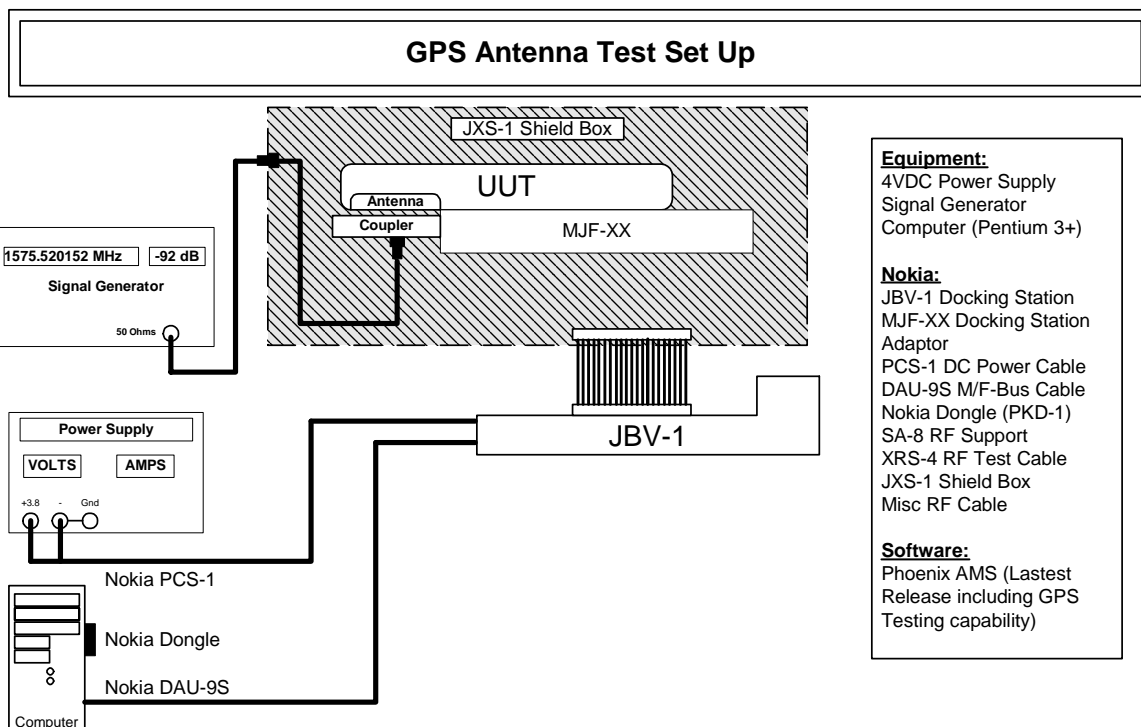


Figure 3: GPS Radiated Testing (Model 3586i only)

GPS Testing Equipment

- Power Supply
- Signal Generator up to 2 GHz
- Computer (Pentium 3, W2000)
- JBV-1 Docking Station
- MJF-19 Docking Station Adaptor
- PCS-1 DC Power Cable
- DAU-9S M/F-Bus Cable
- RF Test Cables (for GPS RF Port)
- Latest Release Phoenix AMS version w/ GPS Test Component

